





















VUE D'ENSEMBLE DE L'ASSORTIMENT DE VARIATEURS

	Par commande de phase (RL)			Par interruption de phase (RC)		Variateur universel (RLC)		Variateur 1-10V	Variateur DALI
Symbole	 *	 N	 *	 N	 N	 N	 N	 N *	 *
	Variateur à tactile	Variateur rotatif	Variateur rotatif	Variateur rotatif	Variateur rotatif	Variateur rotatif	Variateur rotatif	Variateur rotatif	Variateur rotatif
Illuminable avec LED	-	●	-	●	●	●	●	-	-
Puissance	25-400 W	40-600 W	60-1000 W	20-300VA	20-600 VA	20-420 W/VA	20-600 W/VA	1-10 V max. 600 VA	justqu'à 25 BE
Fusible	●	●	-	-	-	-	-	●	-
Potentiomètre min.	-	●	-	●	●	●	●	●	●
Potentiomètre max.	-	-	-	-	-	●	●	●	●
Schéma 3	-	●	-	●	●	●	●	-	-
Entrée de contact	●	-	-	-	-	-	-	-	- **
EDIZIOdue, appareils complets blancs, lumineux									
Code Feller	-	40600.RL.FMI.61.xx	-	40300.RC.FMI.61.xx	40600.RC.FMI.61.xx	40420.RLC.FMI.61.xx	40600.RLC.FMI.61.xx	-	-
E-No	-	E No 548 260 6xx	-	E No 548 290 6xx	E No 548 270 6xx	E No 548 250 6xx	E No 548 240 6xx	-	-
pour toutes les autres couleurs, système modulaire lumineux									
Code Feller	-	40600.RL.BSM.xx	-	40300.RC.BSM.xx	40600.RC.BSM.xx	40420.RLC.BSM.xx	40600.RLC.BSM.xx	-	-
E-No	-	E No 548 263 7xx	-	E No 548 293 7xx	E No 548 273 7xx	E No 548 253 7xx	E No 548 243 7xx	-	-
EDIZIOdue, appareils complets blancs, non lumineux									
Code Feller	30490.FMI.61	40600.RL.FMI.61	31000.FMI.61	40300.RC.FMI.61	40600.RC.FMI.61	40420.RLC.FMI.61	40600.RLC.FMI.61	40600.1-10V.FMI.61	40080.FMI.61
E-No	E No 548 812 000	E No 548 260 000	E No 548 732 000	E No 548 290 000	E No 548 270 000	E No 548 250 000	E No 548 240 000	E No 548 280 000	E No 548 502 000
Standard, appareil complet blanc, lumineux									
Code Feller	30490.PMI.61	40600.RL.PMI.61	31000.PMI.61	40300.RC.PMI.61	40600.RC.PMI.61	40420.RLC.PMI.61	40600.RLC.PMI.61	40600.1-10V.PMI.61	40080.PMI.61
E-No	E No 348 820 000	E No 348 260 000	E No 348 730 000	E No 348 290 000	E No 348 270 000	E No 348 250 000	E No 348 240 000	E No 348 280 000	E No 348 609 000
FLF, appareil complet blanc, lumineux									
Code Feller	-	40600.RL.FLF.6/5.61	31000.FLF.6/5.61	40300.RC.FLF.6/5.61	40600.RC.FLF.6/5.61	40420.RLC.FLF.6/5.61	40600.RLC.FLF.6/5.61	40600.1-10V.FLF.6/5.61	40080.FLF.6/5.61
E-No	-	E No 428 672 000	E No 428 652 000	E No 428 674 000	E No 428 673 000	E No 428 675 000	E No 428 676 000	E No 428 620 000	E No 428 609 000
Charge / Consommateur									
Charge								-	-
R 	●	●	●	●	●	●	●	-	-
R 	●	●	●	●	●	●	●	-	-
L 	●	●	●	-	-	●	●	-	-
C 	-	-	-	●	●	●	●	-	-
avec BE 	-	-	-	-	-	-	-	● avec BE pour 1-10V	● avec BE DALI
avec BE 	-	-	-	-	-	-	-	● avec BE pour 1-10V	● avec BE DALI

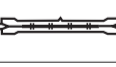
Exemple:
Variateur rotatif universel
EDIZIOdue 420VA noir, monté
avec LED blanche

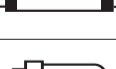

Explication des symboles

-  Lampes halogènes haute tension (HT) et lampes à incandescence à charge ohmique
-  Lampes halogènes basse tension (BT) avec transformateur enroulé et charge inductive
-  Lampes halogènes basse tension (BT) avec transformateur électronique et charge capacitive

- * non illuminable
- ** Stations secondaires passives possibles
- N Nouveauté

Précision

En raison de normes insuffisantes, Feller ne peut pas garantir le bon fonctionnement de lampes LED ou économiques réglables. Feller décline toute responsabilité en cas de dégat au variateur ou à la lampe.

Les prises ne doivent pas être alimentées par un variateur!

Aperçu des couleurs LED

	Code Feller	Code E
Bleu	..74	..70
Blanc	..14	..00
Jaune	..34	..80
Rouge	..44	..50
Vert	..84	..60

Aperçu des éléments d'éclairage LED

	Code Feller	Code E
Bleu	660.230V.LED.70	209 990 670
Blanc	660.230V.LED.10	209 990 600
Jaune	660.230V.LED.30	209 990 680
Rouge	660.230V.LED.40	209 990 650
Vert	660.230V.LED.80	209 990 660

Aperçu des sets de recouvrement illuminable

	Code Feller	Code E
blanc	920-40000.FMI.SL.61	378343000
silver	920-40000.FMI.SL.08	378343840
gris clair	920-40000.FMI.SL.65	378343030
gris foncé	920-40000.FMI.SL.67	378343040
noir	920-40000.FMI.SL.60	378343950
vanille	920-40000.FMI.SL.37	378343080
crema	920-40000.FMI.SL.35	378343010
sand	920-40000.FMI.SL.36	378343810
coffee	920-40000.FMI.SL.57	378343890
lemon	920-40000.FMI.SL.88	378343860
olive	920-40000.FMI.SL.80	378343850
berry	920-40000.FMI.SL.41	378343800

Mise en place de l'élément LED

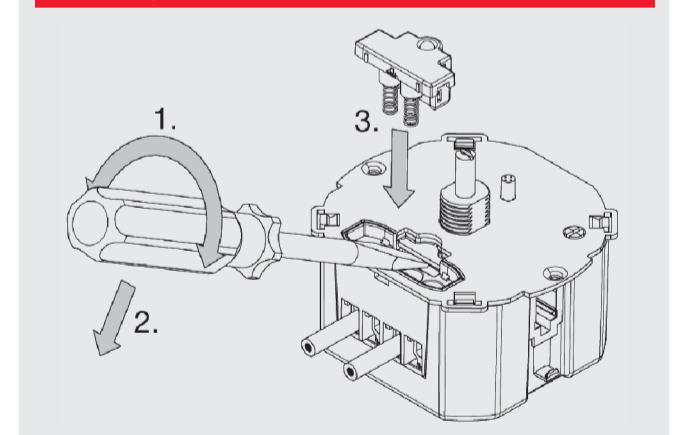

Feller
by Schneider Electric

Feller AG | Postfach 1 | CH-8810 Horgen
Téléphone +41 44 728 72 72 | Téléfax +41 44 728 72 99 | www.feller.ch

Feller SA | Adence Suisse Romande | Caudray 6 | CH-1020 Renens
Téléphone +41 21 653 24 45 | Téléfax +41 21 653 24 51

69.DIM40600-F.1111